



# SimplyShade®

## **Lanai Pro**

*Starlight Auto Tilt*

11' Octagon / SSUM81SL-11



Instruction Manual

Thank you for purchasing SimplyShade's Lanai Pro Starlight Auto Tilt Umbrella.

Please remove all contents from the package, inspect and review checklist.

**CAUTION:** To reduce personal injury and damage to your umbrella, read and follow this assembly and operation guide. We recommend a two-person team for assembly and disassembly. *Save information for future reference.*

## LANAI PRO STARLIGHT AUTO TILT CHECKLIST

A - Finial

B - Canopy/Mainframe

C - Bottom Pole

D - Power Cord/Transformer

*Note: Use only the Power Cord/Transformer supplied.*

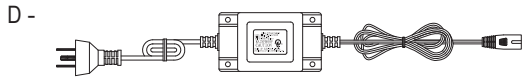
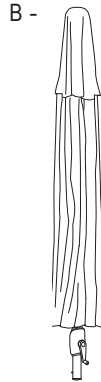

### **IMPORTANT:**

It is imperative to use appropriate base weight for your size umbrella. The minimum base weight recommended for the 11' Lanai Pro is 80 lb.

### **STEP 1** Set Up

Carefully remove umbrella from box. Attach finial to top of canopy/mainframe.



Connect bottom pole plug to canopy/mainframe plug. Twist plug clockwise together to secure connection. 

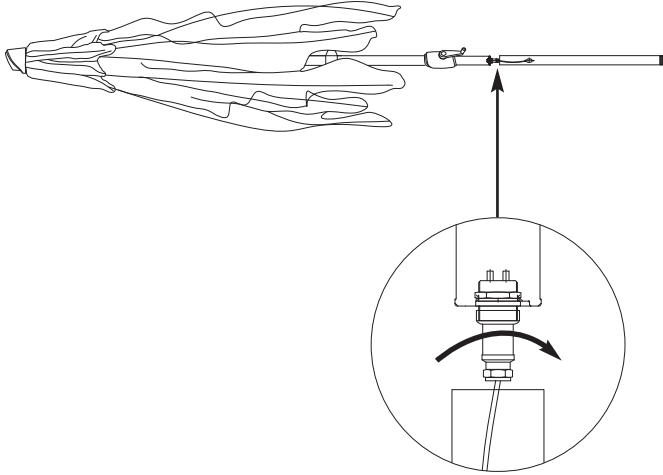

Insert bottom pole into canopy/mainframe pole. Line up button with hole and snap into place.

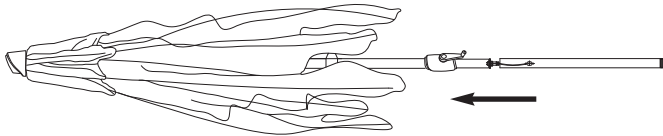

Turn umbrella in upright position. Insert bottom pole into free standing base or through table top. Insert power supply/transformer into umbrella pole. Connect other end of power supply/transformer into wall outlet.

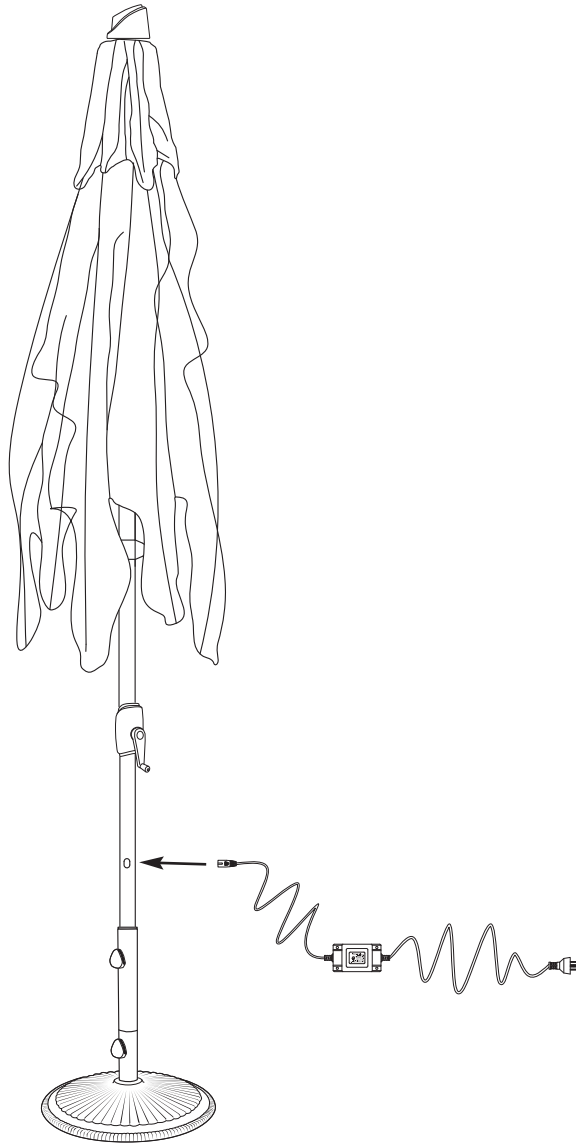

**Note:** The transformer output power is 12V. It is normal for transformer to get warm after long period of use. Avoid sun on power supply/transformer to increase lifetime use.

Be sure not to drop transformer. *Note: Use only the Power Cord/Transformer supplied.*

## STEP 2 Operating Umbrella

Crank handle clockwise to open umbrella to its fully open position. To turn umbrella rib lights on or off, press on/off switch located on crank housing.

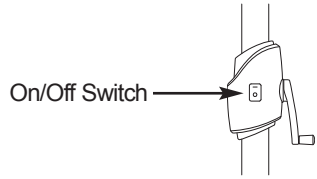
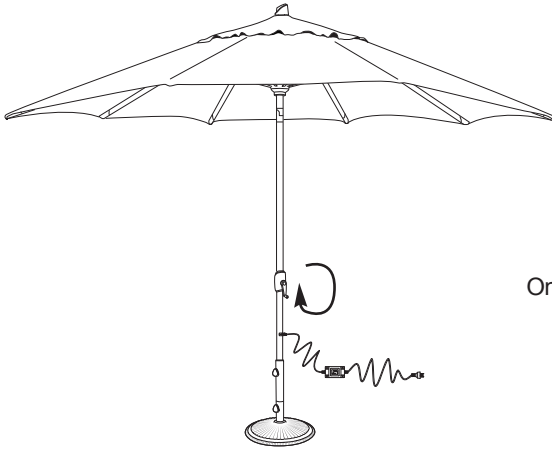

To tilt, continue to turn the crank to desired position.



### STEP 3 Closing Umbrella

Turn crank handle in counter clockwise direction to bring umbrella back to a horizontal position. Turn umbrella off by clicking switch to off position.

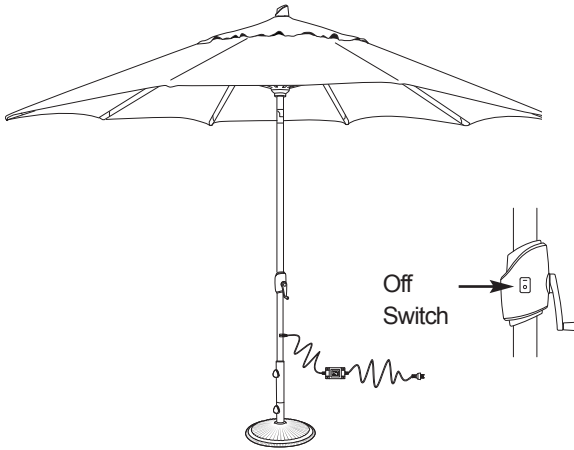

To close, turn crank handle in counter-clockwise direction to close umbrella.

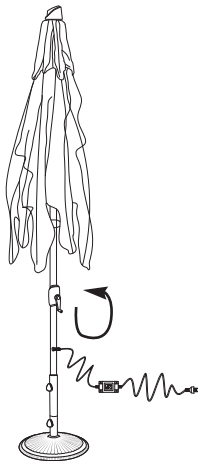

To store umbrella away, unplug power supply/transformer from wall and umbrella pole. Repeat Step 1 process in reverse to store.

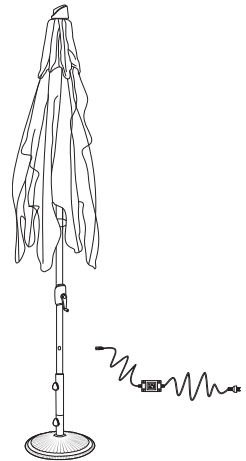

**Note:** During disassembly, it is important to loosen knob of plug *inside* umbrella poles **first**, then remove bottom pole from mainframe/canopy. If not, the wire will be split and result in damage to lighting.

## S A F E T Y P R E C A U T I O N S :

- To reduce risk of personal injury in which a person is injured or harmed, and/or damage to personal property, read and follow the Assembly Guide prior to assembling and operating umbrella and base.
- Close and store the umbrella in windy conditions or when a storm approaches. Never allow the umbrella to flap in the wind; this could cause personal injury, damage to personal property, damage to umbrella and/or umbrella canopy. Do not use tilting function during windy conditions.
- Keep umbrella secured to umbrella base at all times. Base knobs may loosen over time. Simply tighten base knobs during use of umbrella to ensure umbrella is secure.
- Do not leave open umbrella unattended. If damage occurs, this is not covered by the warranty.
- When adjusting the umbrella, make sure that no person(s), item(s) or personal property are close to the umbrella. This is important to prevent injury or material damage.
- Do not allow children to play on or with umbrella or umbrella base.
- When adjusting or assembling the umbrella or umbrella base, make sure fingers, toes or any other parts of the body are clear from moving parts. Failing to do so may result in serious injury.

## C A R E A N D M A I N T E N A N C E :

- When not in use, close and cover umbrella with a protective cover (sold separately).
- Allow a wet canopy to dry opened up.
- If necessary, clean the fabric with lukewarm water, mild detergent, and a sponge.
- Wipe sliding marks on the aluminum poles with a damp cloth.

### Winter Storage:

- Store in a dry, protective place.

### After the Winter:

- Check the condition and function of the umbrella. Any defects must be repaired by a professional.

## WARRANTY:

The manufacturer warrants that this umbrella, when subject to normal and proper use, will be free from manufacturing defects for a period of one year from the original date of purchase. Should any defect occur during the specified time period, the manufacturer will repair, replace, or provide replacement parts, at its own option. Limited warranty against fabric fading, based on fabric grade. Warranty is not transferable.

We will not warrant any claim coverage unless both the original sales receipt and request form are sent to us. Any items that are returned for warranty or non warranty purposes must be issued a Return Authorization Number. Only

upon issuance of an RA # and inspection by our QC department will credit or replacement of umbrella be issued. It is the customer's responsibility to pay the freight on return products or replacement parts. **ALL RETURNED ITEMS MUST INCLUDE THE RA# CLEARLY WRITTEN ON THE RETURN PACKAGE** or package will be refused by our warehouse personnel.

NOTE: Damages and failure caused by improper use due to neglect of reasonable and necessary care are not covered by this warranty.

Additionally, acts of nature (including but not limited to wind, hurricanes, tornadoes, and storms) are not covered by this warranty.



[www.simplyshade.com](http://www.simplyshade.com)